

## FWB2801-J

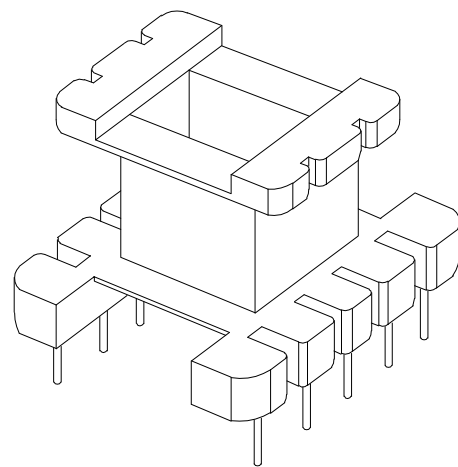
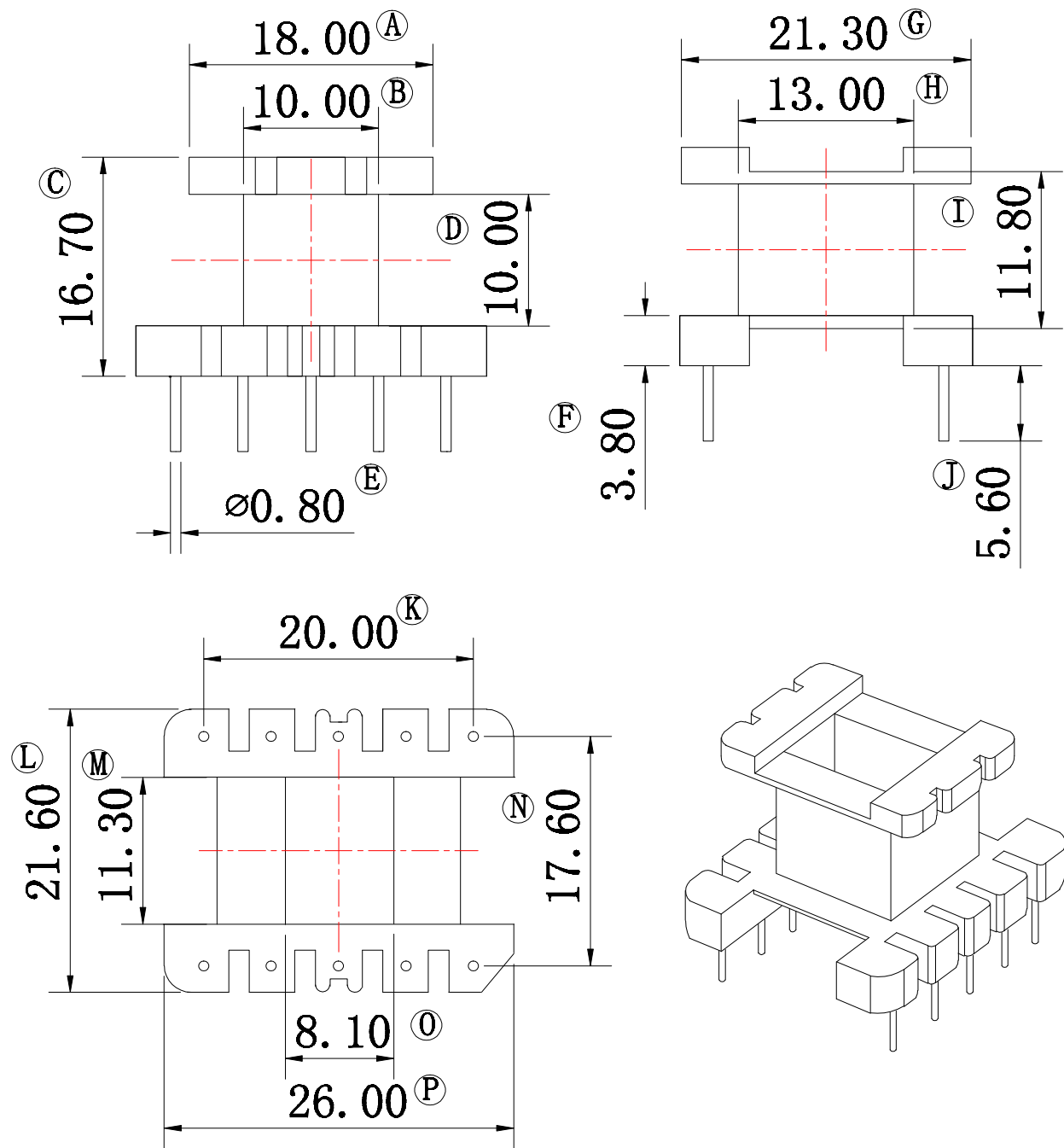

REV	REVISION RECORD	DATE	REV	REVISION RECORD	DATE
A			C		
B			D		

NAME	EE28 5+5P	MATERIAL	PHENOLIC	SCALE		ANGLE	$\pm 1^\circ$
DRAWING NO.	FWB2801-J	PIN MATERIAL	CP WIRE	UNIT	m/m	REV	A
TOLERANCE OF PIN PITCH $\pm 0.20$				<b>HAINING FERRIWO ELECTRONICS CO.,LTD.</b>			
PIN TENSION LOAD      kg MN		UL REC: 94V-0		TEL: +86-573-87088701 FAX: +86-573-87081130			
TOLERANCE: 0<L≤4: ±0.2    4<L≤16: ±0.3    16<L≤63: ±0.4				Web: www.ferriwo.com Email: sales@ferriwo.com			